

HINTS & TIPS 

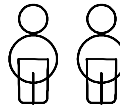

Please retain your assembly instruction for future use

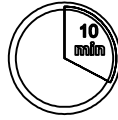



This assembly requires two people

PRODUCT ASSEMBLY - Step by step guide

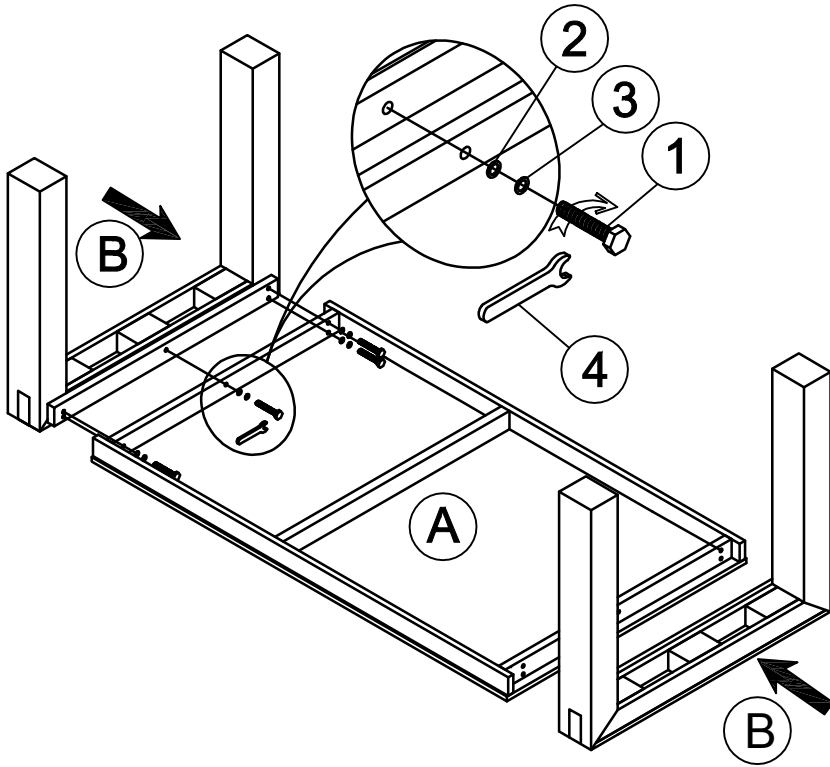
Step 1

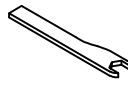

1		M10x60mm	10
2		Ø10x23mm	10
3		Ø10mm	10
4		Ø10x50mm	01

Step 2

Assembled

