

PARTS LIST			
ITEM	QTY	PART NUMBER	DESCRIPTION
1	3	HANDLE	
2	18	SCREW 4x18	
3	2	WEDGE PVC	
4	6	SCREW 3x16	
5	6	SCREW 5x30	

fig.1

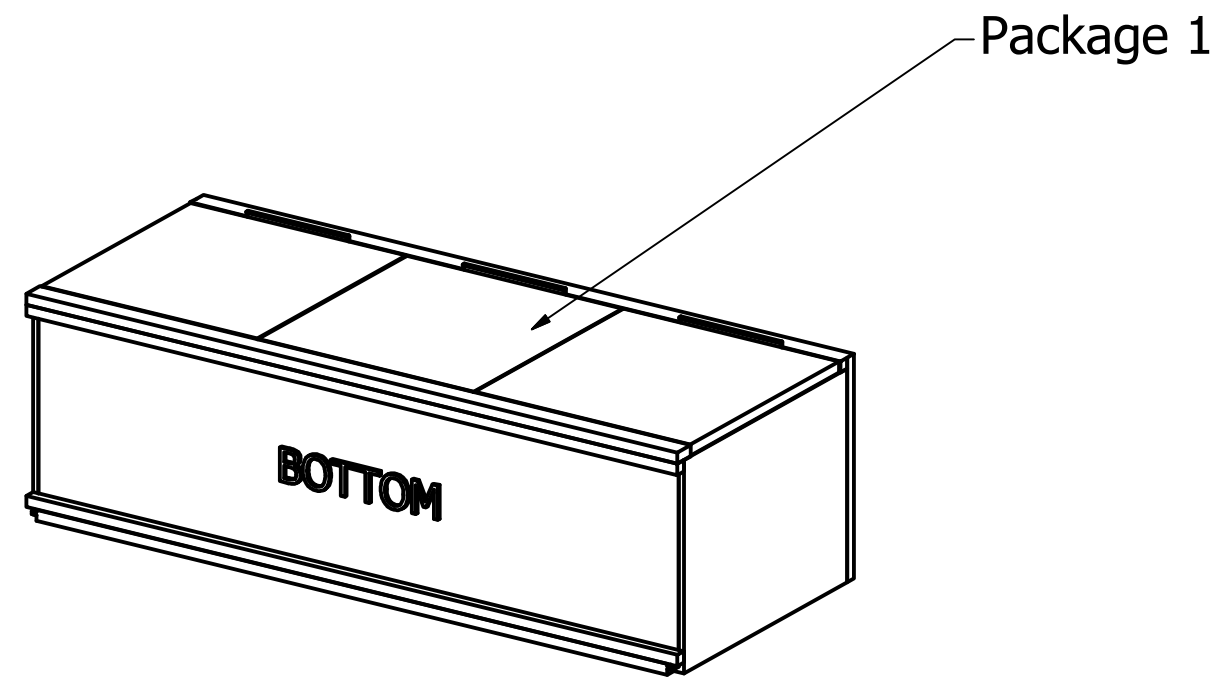

fig.2

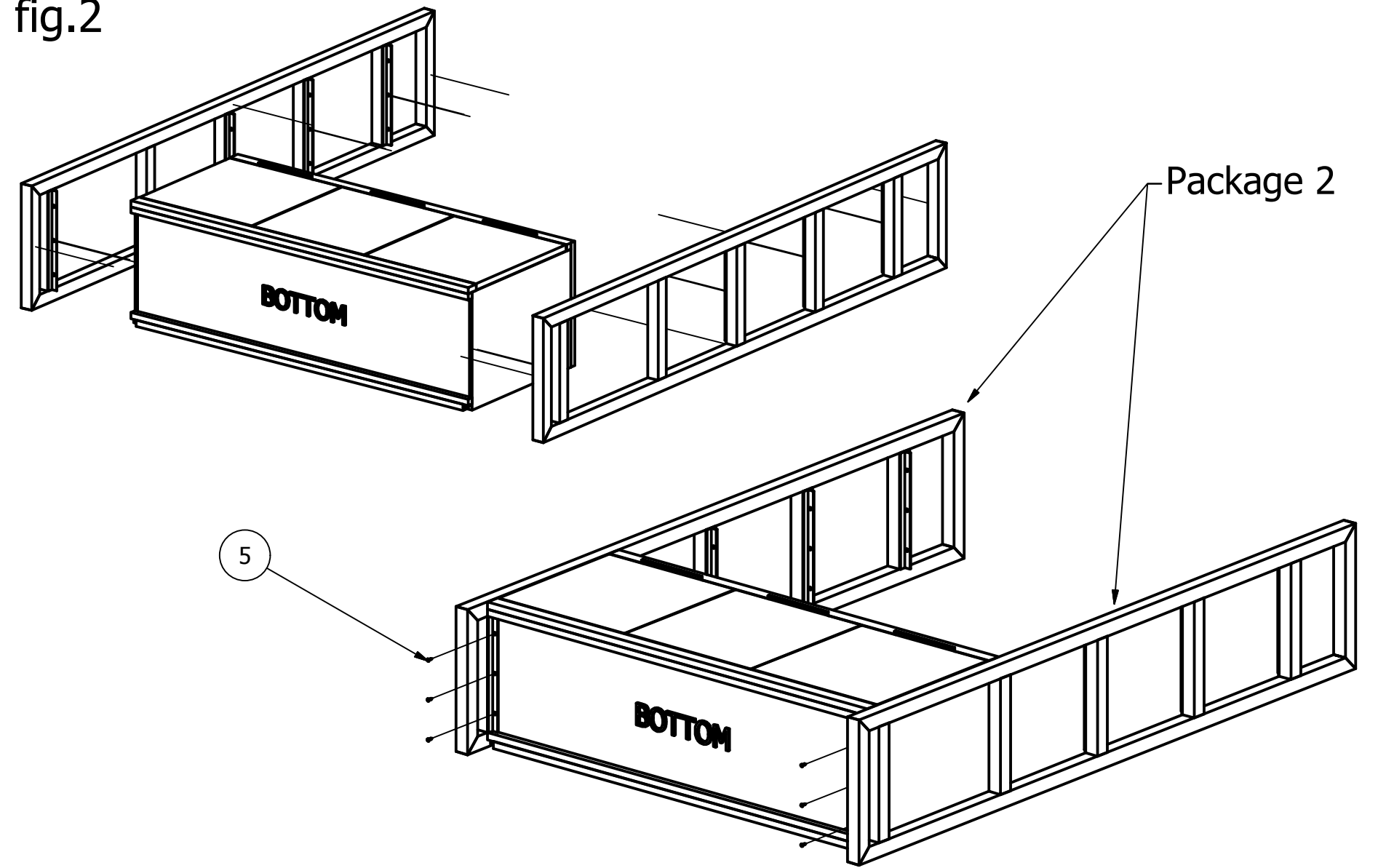

fig.3

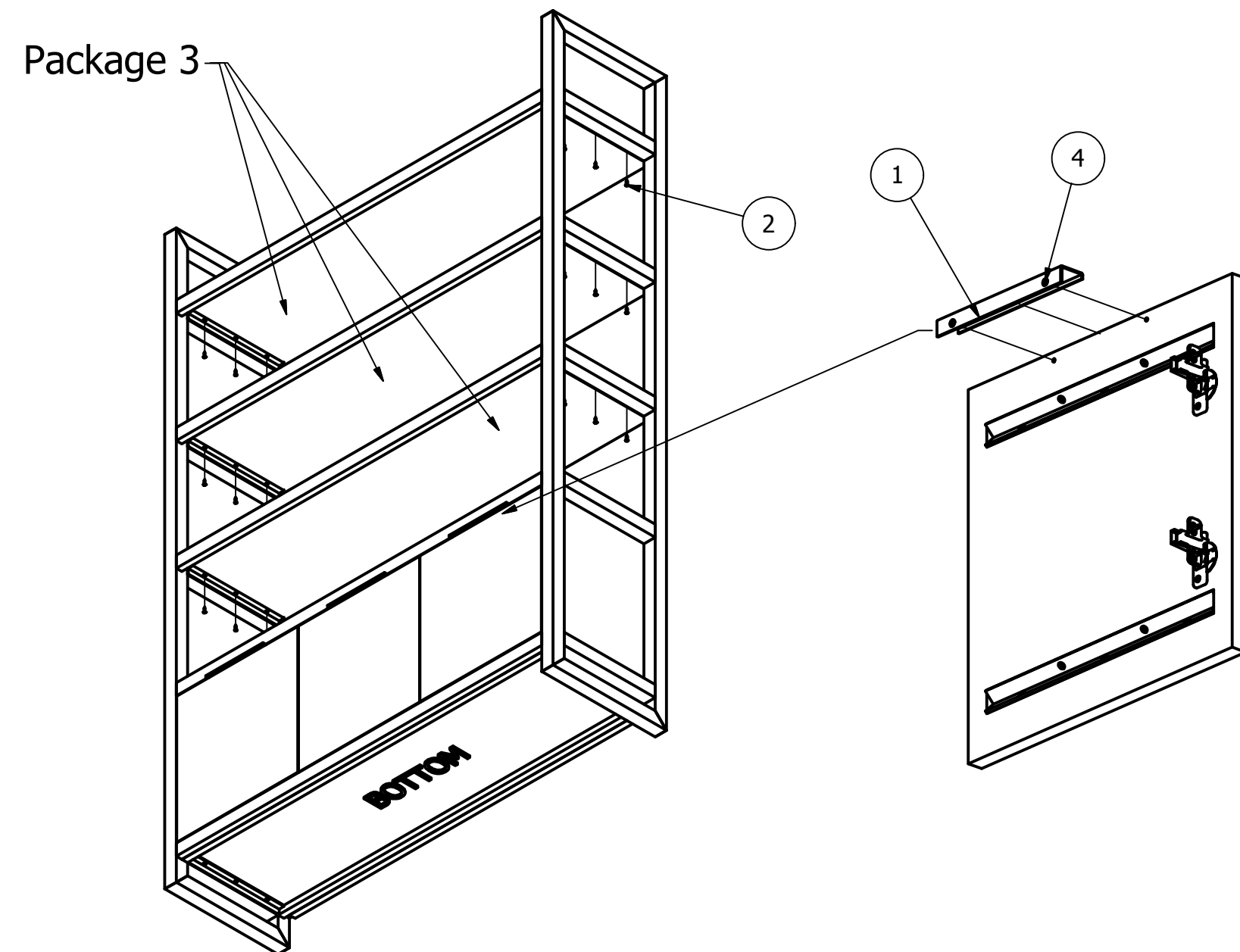

fig.4

